

Honeywell®

Portable Evaporative Air Cooler

OWNER'S MANUAL

Read and save these instructions before use

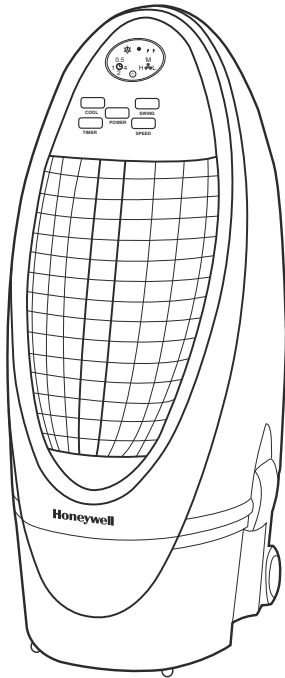

Model: CS10XE

Voltage rating: 110 Volt AC, 60Hz
Power rating: 100 Watts

Made in China.

INDEX

Read all instructions carefully before setting up and operating the unit, and please keep this instruction manual for future reference. This manual is designed to provide you with important information needed to setup, operate, maintain, and troubleshoot your cooler. Failure to follow these instructions may damage and/or impair its operation and void the warranty.

SECTION	PAGE
1. THANK YOU	2
2. USER TIPS	3
3. SAFETY RULES	5
4. PARTS DESCRIPTION	7
5. USE & OPERATION	8
Control Panel	8
Function Buttons	9
Remote Control	12
Fill Water	13
6. CLEANING & MAINTENANCE	14
7. TROUBLESHOOTING GUIDE	16
8. TECHNICAL SPECIFICATIONS	18
9. ELECTRICAL WIRING DIAGRAM	18

THANK YOU

THANK YOU!

Congratulations on your purchase of this versatile Honeywell Evaporative Air Cooler. For optimum cooling performance from your unit, fill the water tank with water & ice (if available) to increase its cooling power.

Please read these instructions carefully.

COOL ~ EFFICIENT ~ NATURAL

Evaporative air cooling is the natural way of cooling, similar to a breeze blowing across a lake. This breeze drops the temperature and has a relaxing cooling effect.

The evaporative air cooler cools the air by means of the evaporation of water. When water evaporates into the air, the result is a mixture of air and water molecules. This chemical change requires heat which is taken from the water molecules, resulting in cooler air propelled from the unit.

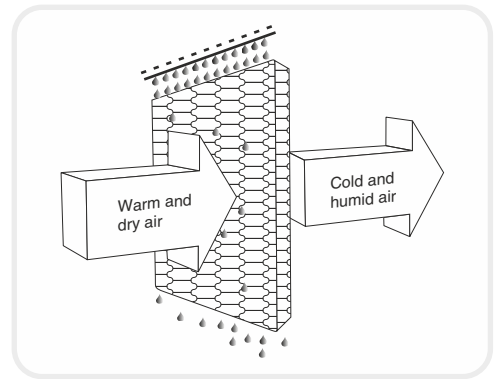
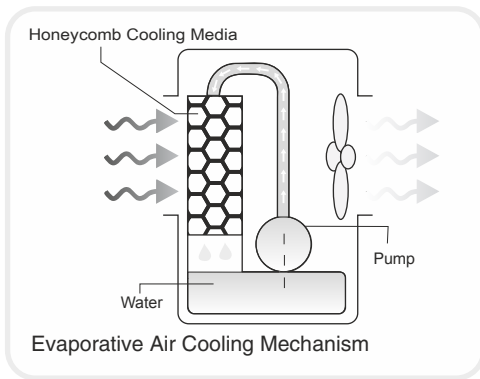

USER TIPS

The recommended maximum relative humidity level is 60% or less, which allows a noticeable temperature decrease. The temperature decrease will be greater in drier climates because higher evaporation occurs when the humidity is low.

The evaporative air cooler should not be used in enclosed spaces. It must be kept level and there must be water in the water tank. The room should have doors and windows opened to allow free air flow. The evaporative air cooler works best when placed near an open window, so that outside air is drawn into the evaporative air cooler, the air circulates in the room, then exits via the door. The maximum cooling effect is felt when a person is in the flow of air coming out of the evaporative air cooler.

The evaporative air cooler can also be used to humidify dry air during cool weather. To be used for humidification the windows and doors should be closed to allow the humidified air to accumulate. The evaporative air cooler is not an air conditioner as it does not use a compressor or refrigerant gas. It should not be expected to cool as efficiently as a refrigerated air conditioner.

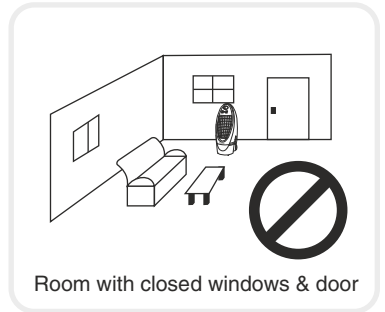
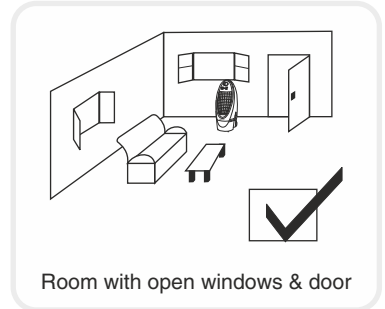

NOTE

When the product is used for the first time the Honeycomb cooling media will have an odour which will dissipate in a week or so of initial use.



READ AND SAVE THESE INSTRUCTIONS:

When using electrical appliances, basic safety precautions should always be followed:

- Your cooler runs on 110 Volt AC, 60 Hz current. Check the household voltage to ensure it matches the appliance's rate specification.
- Before operating the product remove it from its packaging and check it is in good condition.
- DO NOT operate any product with a damaged cord or plug. We recommend not using an extension cord with this appliance.
- DO NOT run power cord under carpeting, or cover it with rugs or runners. Keep the cord away from areas where it may be tripped over.
- Always unplug the product before refilling the water tank.
- Always unplug the appliance from the power source before cleaning, servicing or relocating the unit.
- Remove the power cord from the electrical receptacle by grasping and pulling on the power cord plug-end only, never pull the cord.
- DO NOT use the product in areas where gasoline, paint or other flammable goods and objects are stored.
- When using the "COOL" setting, please check the water tank to ensure it is full. Operation of this unit on the "COOL" setting with an empty tank may result in damage to the water pump.



110V AC 60Hz

SHOCK HAZARD



WATER LEVEL INDICATOR

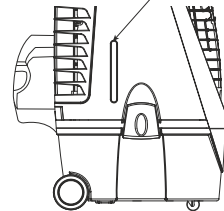

SAFETY RULES

- DO NOT attempt to repair or adjust any electrical or mechanical functions of the cooler, as this may void the warranty.
- DO NOT cover the air inlet or outlet on the appliance as this may cause motor damage.
- DO NOT insert or allow objects to enter any ventilation or exhaust opening as this may damage the product and could cause an electrical shock or fire.
- DO NOT operate with the Honeycomb media removed as this will overload and damage the motor.
- DO NOT leave the appliance operating unattended for any extended period of time.
- DO NOT let children play with this appliance, packaging or plastic bags.
- If the unit is damaged or it malfunctions, do not continue to operate it. Refer to the troubleshooting section and /or please seek professional advice.
- Place the unit on a level floor.
- This product is not intended for use in wet or damp locations.
- Never locate the product where it may fall into a bathtub or other water container. DO NOT use in bathrooms or outdoors.
- When the unit is not in use always store in a dry area.
- This appliance is not intended for use by persons (including children or elderly) with reduced physical, sensory or mental capabilities, or lack of experience and knowledge, unless they have been given supervision or instruction concerning use of the appliance by a person responsible for their safety.
- Always grip the side handles to move the unit.

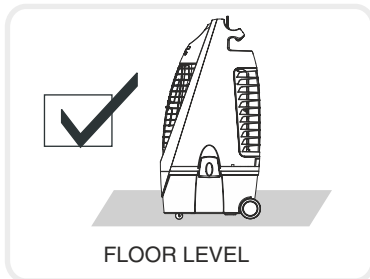
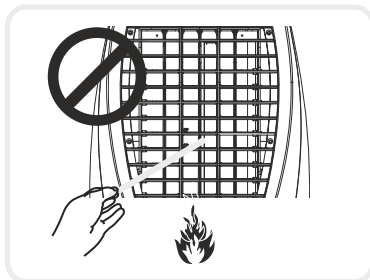
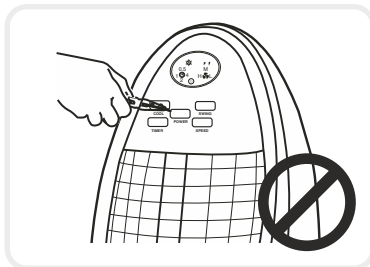

PARTS DESCRIPTION

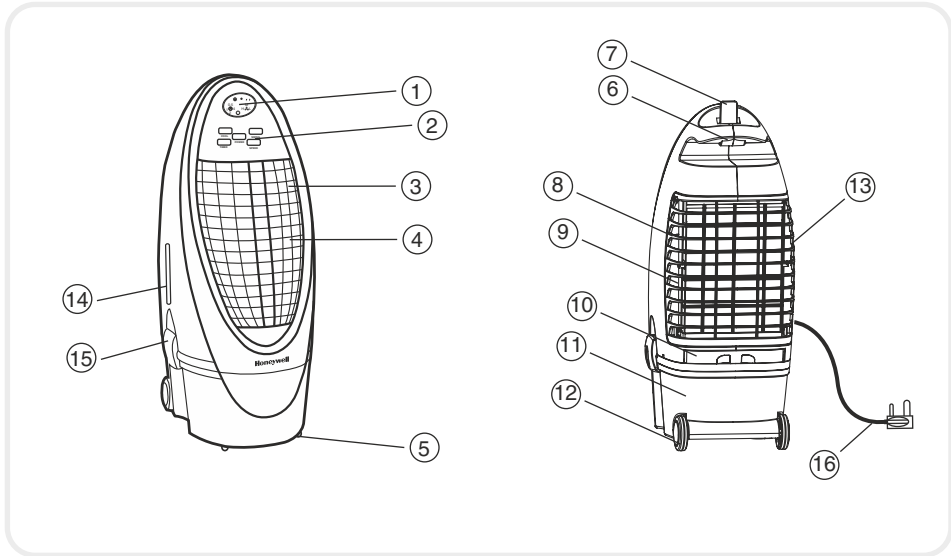





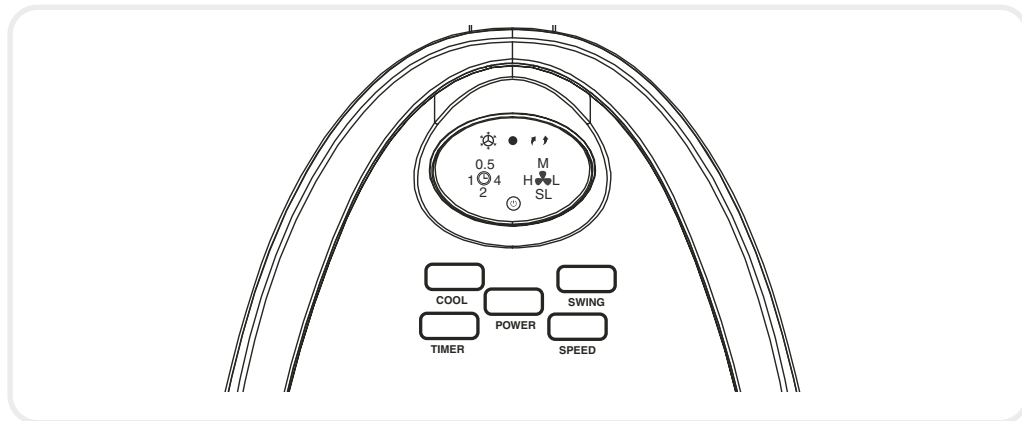

- 1 Display
- 2 Control Panel
- 3 Louvers
- 4 Front Grill
- 5 Front Castors
- 6 Handle
- 7 Remote Control
- 8 Honeycomb Cooling Media

- 9 Rear Grill
- 10 Water Fill Tray
- 11 Water Tank
- 12 Rear Wheels
- 13 Carbon Filter
- 14 Water Level Indicator
- 15 Water Tank Lock Clip
- 16 Power Cord & Plug

CONTROL PANEL



Icons on LED

	Cool		Swing
	Low speed	0.5	
	Medium speed	1  4	Time delay set
	High speed	2	
	Sleep		Power ON / OFF

FUNCTION BUTTONS

POWER

Press the 'POWER' button to turn the unit on. To turn the unit off, press the button again. The cooler will start automatically at medium speed. After a few seconds the speed will switch to low.



SPEED

Press the 'SPEED' button repeatedly and the speed will change. The indicator light will show the selected speed.

High ↔ Medium ↔ Low ↔ Sleep



When sleep is selected airflow will randomly vary between High, Medium and Low.

TIMER

Press the TIMER button until the indicator light moves to your desired time. Once the set time has passed, the unit will automatically shut off. The Timer function allows you to program the unit for up to 7.5 hours of use.

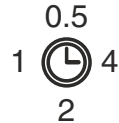

USE & OPERATION

SWING

Press the "SWING" button. The indicator light will come on and the louvers will begin to move from right to left automatically. Manually adjust the horizontal louvers to change vertical airflow.

UP-DOWN AIR FLOW

To adjust the vertical direction of air flow, adjust the horizontal louvers located behind the front grill manually.

COOL

To begin cooling the desired area press the "COOL" button. The indicator light will come on and the water pump will operate. You can feel the cooler air after the Honeycomb media is completely wet.

LOUVERS MOVEMENT

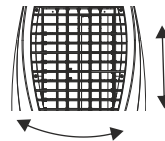

LOW WATER ALARM FUNCTION

The unit is equipped with a low water sensor. When water in the tank is below the minimum level, you will hear 10 beeps and the COOL LED indicator will flash continuously. At the same time the power to the pump inside the unit will be cut off to protect the life of the pump.

To disengage the alarm function, turn off and unplug the unit from the power outlet, and fill the tank with water above the minimum level.

To turn off the alarm function and continue to use it in FAN mode, turn off the unit and turn the unit on. If COOL button is pressed again without filling the tank with water, low water alarm will activate again.

REMOTE CONTROL

- Power: On / Off
- Speed: Low / Medium / High
- Cool: Pump ON / OFF
- Swing: Controls the motion of the louvers
- Timer: Controls timer function for automatic shut off

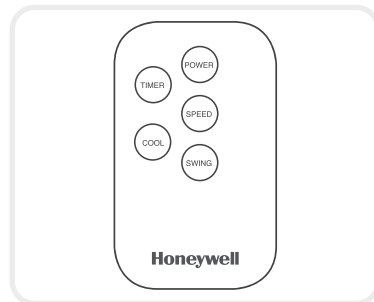

NOTE

- The remote control for your air cooler already has its battery installed
- The remote control requires a CR2032(1 x 3V) coin type or equivalent battery for replacement.
- Always point the remote control signal transmitter towards the unit when operating.
- Make sure that the signal path is not obstructed.
- Remove the battery if the unit is not going to be used for an extended period of time.
- Do not drop the remote control.



FILL WATER

Open the Water Fill Tray located at the back of the unit. The water tank of the unit holds up to 10 Litres of water.

Water level display window is located on the front of the unit. Refill the water tank when water level is low. Do not fill water above the Max water level mark. Check water level in the tank before running the "COOL" function. Please be sure water in the tank is always above minimum water level mark. Running the unit with inadequate water may cause pump failure. If ice is available you may add ice in the top compartment to enhance the cooling performance.

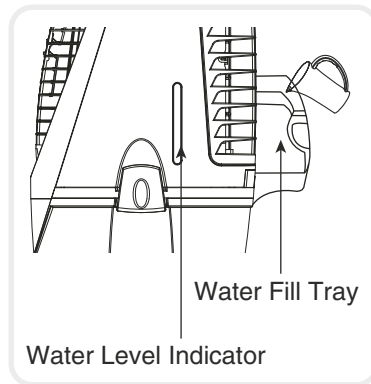

CAUTION

Unplug from power when refilling.



WARNING

- Before cleaning the unit, switch it to the "off" position and remove the plug from the power socket.
- To clean the outside, use a damp cloth to remove dirt and dust.
- Never use corrosive elements or any chemicals to clean this product.
- When the product is not in use, store the unit in a dry place out of direct sunlight.



CLEANING & DRAINING THE WATER TANK:

- Turn the power "off" and disconnect the air cooler from the power supply.
- Move the unit to a location where it can be drained. Remove the cap from the drainage tube and allow the tank to empty (see parts description on page 7).
- Once the tank is empty, unlock the latches on both sides and lift off the cooler top section as shown in the figure and place it vertically on the floor. Be careful not to bend the water pickup tube that hangs below the unit.
- Refill the water tank with clean water and drain it completely.
- Clean the water tank with detergent or a damp cloth and rinse it thoroughly.
- Place the unit top carefully on the tank and lock the latches. Refill the water tank with clean water, up to the maximum level. The air cooler is now ready to be used. This cleaning process should be repeated weekly to maintain the integrity of the unit and to remove particles filtered from the air.

Water Pick Up Tube

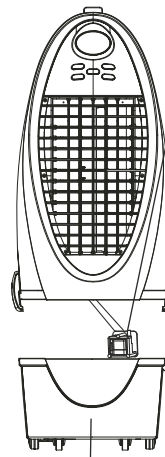

Detached Water Tank

CLEANING THE FILTER AND HONEYCOMB

- The appliance is supplied with carbon filter & honeycomb cooling media.
- Always keep the carbon filter clean. You can wash the carbon filter at least twice a year or whenever you feel necessary.
- The carbon filter and honeycomb media are located inside the back panel. Open the back panel by pulling out the back grill to clean or replace the carbon filter or honeycomb media. If you have any question about the carbon filter and honeycomb media be replaced , please contact service centre.
- Draining the water reservoir and refilling with fresh water at least once a week will greatly reduce mineral deposits in the pads and help to extend the life of Honeycomb cooling media.
- Do not run the unit in COOL mode with stale water in the tank. You must empty the water tank and refill with fresh water, especially if the tank has not been cleaned in a long time.
- The cleaning frequency for the Honeycomb media depends on local air and water conditions. In areas where the mineral content of water is high, mineral deposits may build up on the honeycomb cooling media and restrict air flow. Draining the water reservoir and refilling with fresh water at least once a week will help reduce mineral deposits. If mineral deposits remain on the Honeycomb media, the media should be removed and washed under fresh water. The media should be cleaned every two months or sooner, depending on your needs.
- For best results allow the honeycomb cooling media to dry after each use by turning off the cool function 15 minutes before turning the unit off.

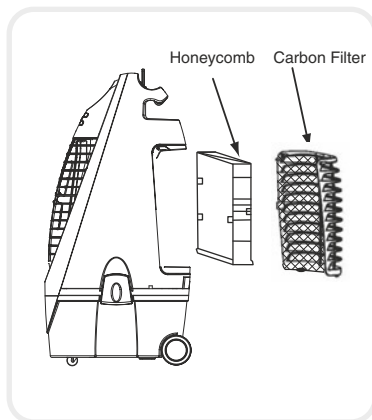
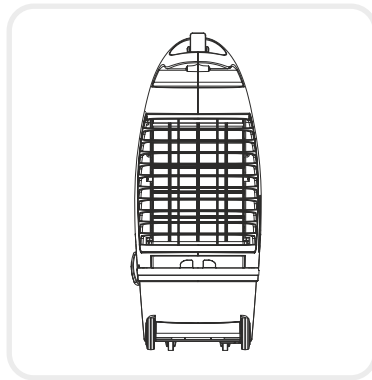

TROUBLESHOOTING GUIDE

PROBLEM	POSSIBLE CAUSE	SOLUTION
No discharge of air	Cord is not plugged in.	Make sure power cord is plugged in and the supply switch in ON.
	Power is not on.	Try to turn the unit ON by pressing buttons on control panel or remote control.
Not Cooling / Unit is making noise	Pump is not turned ON.	Turn on COOL function from remote or control panel.
	Low or no water in tank, when COOL is selected.	Refill water tank.
	Damaged Pump or Calcium deposits on blower.	Contact service centre.
Odour omission	New Unit.	When the unit is used for the first time, the Honeycomb cooling media will have an odour, which will dissipate within a week of initial use.
	Old Unit.	There may be an algae issue, Replace the honeycomb cooling media. Contact service centre.

PROBLEM	POSSIBLE CAUSE	SOLUTION
The unit does not respond	Remote control batteries.	Check batteries, Replace if needed. Try to operate using the control panel.
	Damaged PCB	Try with remote control. If the unit responds, PCB board fasteners may be loose. Contact service centre.
		If neither remote control nor control panel works, PCB board may be damaged. Contact service centre.

TECHNICAL SPECIFICATIONS

MODEL NO.

CS10XE

Voltage	110V
Frequency	60Hz
Wattage	100 Watts
Water Tank Capacity	10 Litre
Cooling Media	Honeycomb
Product Dimension	360(L) x 315(W) x 720(H) mm
Net Weight	8.4 Kg

ELECTRICAL WIRING DIAGRAM

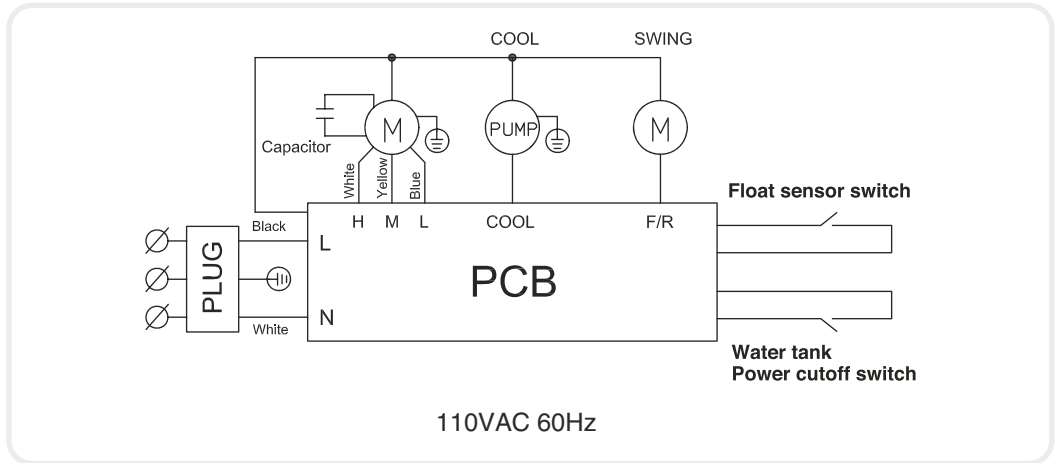

Authorized Distributor for :

© 2012 AirTek International Corporation Limited
The Honeywell Trademark is used under license from
Honeywell International Inc.
Honeywell International Inc. makes no representation or
warranties with respect to this product.
Manufactured by AirTek International Corporation Limited.

Honeywell